

# PF U buisschiller



Peelers

**Instruction Manual**

# 1. Dimension ranges

## 1.1. Base version

For pipe dimensions	[mm]	63-315
For pipe dimensions	IPS	2-12
For pipe dimensions	DIPS	3-12

# Table of contents

<b>1.</b>	<b>Dimension ranges .....</b>	<b>2</b>
1.1.	Base version .....	2
<b>2.</b>	<b>Information about this manual .....</b>	<b>6</b>
2.1.	Applicable Documents.....	6
<b>2.2.</b>	<b>Warnings .....</b>	<b>7</b>
2.2.1.	Description of the structure of the warnings .....	7
2.2.2.	List of warnings .....	8
<b>2.3.</b>	<b>Symbolism .....</b>	<b>8</b>
2.3.1.	General symbols and signs .....	8
2.3.2.	Warning symbols.....	9
2.3.3.	Requirement symbols.....	9
2.3.4.	Prohibition symbols .....	10
<b>2.4.</b>	<b>Preconditions, requirements and steps .....</b>	<b>10</b>
2.4.1.	Preconditions and requirements.....	10
2.4.2.	Steps without fixed sequence.....	10
2.4.3.	Action steps with a predetermined sequence.....	10
<b>3.</b>	<b>Warranty and liability .....</b>	<b>11</b>
<b>4.</b>	<b>Identification .....</b>	<b>11</b>
4.1.	Product labeling .....	11
4.2.	Information about the manufacturer.....	11
4.3.	Type plate .....	12
<b>5.</b>	<b>Product description.....</b>	<b>13</b>
5.1.	Purpose and intended use.....	13
5.2.	Improper use.....	13
5.3.	Modifications and alterations.....	14
5.4.	Ambient conditions .....	14
5.4.1.	Environmental conditions .....	14
5.4.2.	Space requirements .....	14
5.4.3.	Weight .....	14
5.5.	Assembly and mounting.....	14
5.6.	Overview and component description .....	15
5.6.1.	U-Peelers with narrow peeling blade (63-180 mm) .....	15
5.6.2.	U-Peelers with wide peeling blade (200-315 mm).....	15
5.6.3.	Drive and feed .....	16
5.7.	Description of the function.....	16
5.8.	Safety features.....	16
5.8.1.	General .....	16
5.8.2.	List of safety features on the product .....	16
<b>6.</b>	<b>Safety .....</b>	<b>16</b>
6.1.	General safety guidelines .....	17
6.2.	Duty of care of the operator .....	18

- 6.3. Duty of care of the user .....19**
- 6.4. Safety in the work area .....19**
- 6.5. Personal protective equipment.....20**
- 6.6. Qualification of personnel .....20**
- 6.7. Deadlines for recurring checks .....20**
- 6.8. Dangers during individual work phases .....21**
  - 6.8.1. Dangers during transport and assembly.....21
  - 6.8.2. Dangers during operation.....21
  - 6.8.3. Dangers during removal .....21
- 6.9. Device specific dangers .....22**
- 6.10. Residual risk .....22**
- 7. Scope of delivery ..... 23**
  - 7.1. Metric sizes .....23
  - 7.2. Inch IPS .....24
  - 7.3. Inch DIPS .....24
- 8. Technical data ..... 25**
  - 8.1. Metric sizes .....25
  - 8.2. Inch IPS .....27
  - 8.3. Inch DIPS .....28
- 9. Transport, Installation and removal, storing ..... 29**
  - 9.1. Transport damage .....29
  - 9.2. Packaging .....29
  - 9.3. Assembly and installation .....29
  - 9.4. Storage .....29
- 10. Installation ..... 30**
  - 10.1. General checks and measures before usage .....30
  - 10.2. Using the U-Peeler .....31
    - 10.2.1. Course of action for the peeling of pipe ends .....31
    - 10.2.2. Course of action for the peeling of pipe ends .....31
  - 10.3. Pressing the U-Peeler onto the pipe .....32
- 11. Peeling ..... 33**
- 12. Removal of the U-Peeler ..... 34**
- 13. Maintenance, repair and cleaning ..... 35**
  - 13.1. Qualification of personnel .....35
  - 13.2. Maintenance by laymen .....35
  - 13.3. Maintenance by specialists .....36
  - 13.4. Maintenance cycles for safe operation .....36
    - 13.4.1. Cyclical maintenance activities.....36
  - 13.5. Measures after maintenance or servicing.....37
  - 13.6. Cleaning .....37
  - 13.7. Changing the peeling blade.....37

- 14. Maintenance and service by the customer service..... 39**
- 14.1. Wearing parts .....39**
- 14.2. Addresses of service stations.....39**
- 14.3. Repackaging before transport .....39**
- 15. Decommissioning, Disassemble, Disposal ..... 39**
- 15.1. Environment-friendly disposal.....39**
- 16. Troubleshooting ..... 40**
- 17. PLASSON Subsidiaries worldwide..... 43**

## 2. Information about this manual

This document has been prepared by PF Schweißtechnologie GmbH. All rights to this document, in particular the right of reproduction, placing on the market and translation into other languages, remain exclusively with PF Schweißtechnologie GmbH.

No part of the document may be altered, copied, electronically processed or distributed without the prior written consent of PF Schweißtechnologie GmbH.

Read this instruction manual completely. The handling and use of the product described below are not always self-explanatory. Therefore the knowledge of the technical documentation is obligatory.

Only in this way can you use the product properly, correctly, safely and effectively.

If parts of the technical documentation are damaged, illegible or lost contact your dealer or the manufacturer to obtain the documents again.



### Residual risk

This document informs you about remaining residual risks against which construction and protective measures are not or only partially effective.



### Errata and technical modifications reserved!

All notes and technical specification in this instructions manual were prepared with all necessary care. The manufacturer reserves all rights for technical modifications of the product or its components without prior notice to customers. Technical modifications cannot always be directly transferred to the documentation.

If you are in doubt about the topicality of the documentation please contact your distributor or the manufacturer.

## 2.1. Applicable Documents

### Document

This product does not have additional documentation.

### NOTE



### Read the entire documentation!



Using the product or its components without completely reading and understanding the entire documentation shall be considered as improper use and is strictly forbidden.

## 2.2. Warnings

When using the product, it is always necessary to carry out activities in which danger may occur. In this document, dangerous situations are preceded by warnings, which must be observed under all circumstances.

### 2.2.1. Description of the structure of the warnings

The warnings are provided with a signal word and one or more symbols. The signal word with the pictogram describes the severity of the danger. Below is an example for clarification.



 <b>CAUTION (A)</b>	
	<p><b>Hazard description (B)</b>          Further explanation on the nature and cause of the danger (C)</p> <p>➤ Measures to prevent or avoid the danger (D)</p>

Symbol	Information	Content	Example
O	Signal word	Classification of the danger by symbol and signal word	Caution
B	Danger description	What is the danger and when does it occur?	Danger due to hot surface
C	Possible consequences if the danger occurs	What will or can happen if you do not pay attention to the warning?	The hot surface can cause burns.
D	Measures to avoid the danger	What needs to be done? What must be avoided? What protective measures must be taken?	Keep your distance and wear fire resistant gloves.



### 2.2.2. List of warnings

	<b>General remark</b> This is a remark of a general nature. These advices describe recommended courses of action to enable the user to perform steps quicker and safer. This warning symbol can also indicate important or obligatory general conditions.
---	--

<b>NOTE</b>	
	<b>Potentially harmful situation</b> This signal word indicates a possible dangerous situation for the product, its components, accessories and / or the environment.

 <b>CAUTION</b>	
	<b>Potentially dangerous situation</b> This signal word indicates a danger with a low degree of risk. Failure to do so could result in minor or moderate injury.

 <b>WARNING</b>	
	<b>Dangerous situation</b> This signal word indicates a danger with a medium degree of risk. Failure to do so may result in serious injury or death.

 <b>DANGER</b>	
	<b>Immediate danger</b> This signal word indicates a danger with a high or very high degree of risk. Failure to do so will result in serious injury or death.

### 2.3. Symbolism







In this document, various symbols are used as aids. The meaning of each is explained below.

#### 2.3.1. General symbols and signs











Symbol/sign	Explanation
	Important information





### 2.3.2. Warning symbols

Symbol	Explanation
	General warning symbol
	Warning: Electricity
	Warning: Hot surface
	Warning: Risk of entanglement
	Warning: Risk of cutting or puncturing
	Warning: Risk of injury to the hands / extremities

### 2.3.3. Requirement symbols

Symbol/sign	Explanation
	General requirement
	Information about / in the documentation This symbol indicates that special attention must be paid to the technical documentation.
	At least 2 people required for operation!
	Wear ear protection!
	Wear eye protection!
	Cover long hair with hairnet or cap!
	Use hand protection!
	Wear safety shoes!
	Ground before use!
	Pull out the mains plug!

### 2.3.4. Prohibition symbols

Symbol/sign	Explanation
	General prohibition
	No reaching in!
	Wearing gloves is prohibited!

## 2.4. Preconditions, requirements and steps

### 2.4.1. Preconditions and requirements

If certain prerequisites or conditions are attached to the execution of a work step, these are mentioned separately prior to the process description and marked with an exclamation mark.

#### Example Precondition

- ! Key SW4 is ready.
- ! Case is open.
- ! ...

### 2.4.2. Steps without fixed sequence

Steps that can be performed without a fixed sequence are indicated by an arrow. Nevertheless, the steps are absolutely necessary!

#### Example Steps without fixed sequence

- Wear safety shoes.
- Watch the oil pressure.
- ...

### 2.4.3. Action steps with a predetermined sequence

Steps that must be carried out according to a fixed sequence are provided with a consecutive numbering. These steps can be interrupted by intermediate results or descriptions of running processes, which is represented by a square. When the result of the work steps is reached, this is indicated by a tick.

#### Example Steps without fixed sequence

1. Press button A to start the trimming procedure.
  - ❖ The trimmer starts to trim.
2. Watch the trimming procedure.
3. Press button B to stop the procedure.
  - ✓ Trimming procedure is finished.

### 3. Warranty and liability

Warranty and liability claims for personal injury and property damage are excluded if they are attributable to one or more of the following causes:

- Improper use of the product and its components outside its scope of application.
- Improper assembly, commissioning, operation, maintenance and improper transport of the product including its components.
- Operation of the product including its components with defective or improperly installed safety devices.
- Failure to follow the instructions in the instruction manual.
- Unauthorized structural changes on the product or its components.
- Inadequate monitoring of machine parts that are subject to wear.
- Repairs carried out improperly.
- Disasters due to foreign bodies and force majeure.

### 4. Identification

#### 4.1. Product labeling

Product description: U-peeler

Product type: Tool for the removal of the oxide layer on polyethylene (PE) pipes, as preparation for electrofusion (EF).

#### 4.2. Information about the manufacturer

**PF-Schweißtechnologie GmbH**  
**Karl-Bröger-Str.10**  
**DE-36304 Alsfeld**  
**Germany**

**Tel.:** +49-6631-9652-0  
**Fax.:** +49-6631-9652-52  
**E-Mail:** [info@pfs-gmbh.com](mailto:info@pfs-gmbh.com)  
**Web:** [www.pfs-gmbh.com](http://www.pfs-gmbh.com)

### 4.3. Type plate

The type plate is a unique identifier of the product and is structured as follows:



#### No. Description

- 1 Product code
- 2 Productname in German
- 3 Productname in English
- 4 Transport weight
- 5 Dimensions

## 5. Product description



### Note

When the term "U-Peeler" is used, this includes all variants of the tool. Otherwise, details of each specific feature will be mentioned separately.

### 5.1. Purpose and intended use

The U-Peeler is meant exclusively for the removal of the oxide layer on polyethylene (PE) pipes as preparation for electrofusion (EF). Additionally it is approved for usage on polypropylene (PP) and cross-linked polyethylene (PE-X) pipes.

The U-Peeler can universally be used to peel pipe ends (for welding fittings) and to peel spots on pipes (for welding saddles). The U-Peeler is monodimensional can only be used on one pipe dimension each.

The product may only be used with the components with which it was delivered or with accessories that have been explicitly released for use by PF-Schweißtechnologie GmbH. Only the use of original spare parts and original accessories is permitted. It is forbidden to replace parts or components of the product with third-party products.

The use of the product is reserved to trained professional personnel only. The applicable standards and guidelines (e. g. DVS, CEN, ISO, national standards, etc.), as well as, in particular, the accidental regulations must be complied with. The manufacturer is not liable for damage caused by improper handling or operation.

The described product must only be operated, maintained and repaired by personnel that is familiar with use of the tool and its dangers.

Proper use includes observing all instructions in the entire associated documentation, performing the inspection and maintenance work, in accordance with the instructions in this documentation as well as adhering to the general accident prevention regulations and taking note of all safety and application instructions.

### 5.2. Improper use



### Disclaimer!

The product may not be used for any purposes other than those mentioned. The basic conditions mentioned must be adhered to. The use of the product as a whole or parts thereof for purposes other than those mentioned above shall be considered as improper use.

- The operator or user is liable for improper use!

### 5.3. **Modifications and alterations**

Modifying the product without prior consulting of the manufacturer is forbidden and shall be considered as improper use.



#### **Constructional modifications are subject to prior approval!**

No modifications, additions or conversions of the product or its components may be made without the manufacturer's approval.

In the case of infringements, the warranty and liability claims shall be void.

### 5.4. **Ambient conditions**

#### 5.4.1. **Environmental conditions**

None

#### 5.4.2. **Space requirements**

Note that the U-Peeler requires about 10 cm of space around the pipe to work with it.

#### 5.4.3. **Weight**

No special arrangements required.

### 5.5. **Assembly and mounting**

The product is available in different versions. The assembly and mounting of the individual variants are identical. Special procedures are mentioned separately.

## 5.6. Overview and component description

### 5.6.1. U-Peelers with narrow peeling blade (63-180 mm)

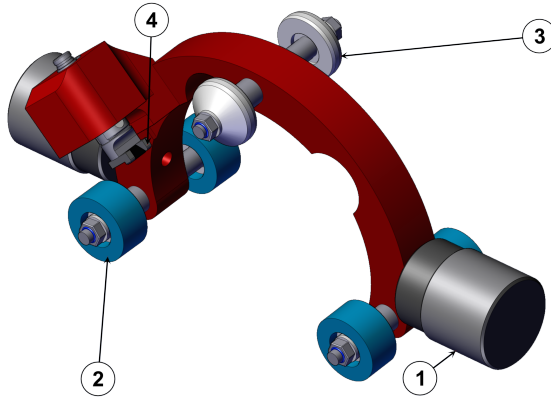

#### Object in graphic

- 1 Adjustment knob M8
- 2 Running wheel 30 mm blue
- 3 Running wheel 30 mm
- 4 Peeler blade 0.2

#### Description

#### Code

- 1\_2400\_016
- 2\_2502\_029
- 2\_2502\_005/3
- 2\_4201\_004

### 5.6.2. U-Peelers with wide peeling blade (200-315 mm)

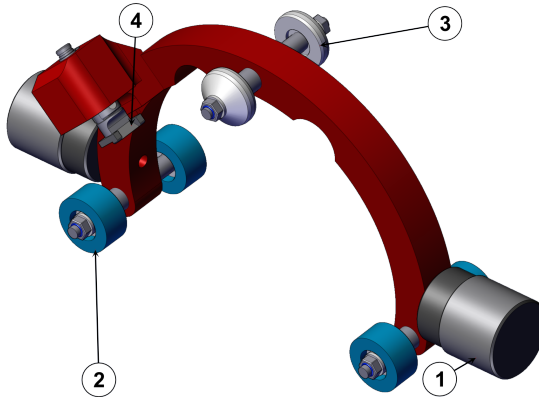

#### Object in graphic

- 1 Adjustment knob M8
- 2 Running wheel 30 mm blue
- 3 Running wheel 30 mm
- 4 Peeler blade 0.3

#### Description

#### Code

- 1\_2400\_016
- 2\_2502\_029
- 2\_2502\_005/3
- 2\_4201\_003

### **5.6.3. Drive and feed**

The U-Peelers are moved manually around the pipe. The feed is fixed.

## **5.7. Description of the function**

After the pipe has been cleaned and marked, the U-Peeler is pressed onto the pipe using the two handles. The mechanical tension holds the tool on the pipe. The marked area is peeled by pulling the tool around the pipe. After completion of the peeling process, the tool is pulled off from pipe at both handles.

## **5.8. Safety features**

### **5.8.1. General**

Safety features on the product or its components serve to protect operators. The product may only be used if all safety-related equipment is present and fully functional.

### **5.8.2. List of safety features on the product**

There are no special safety features on the product.

## **6. Safety**

Our U-Peelers are built according to the latest state of the art and the recognized safety regulations and directions. Nevertheless, dangers to the user or other nearby persons, as well as damage to property values, may arise if the use is improper, easy or incorrect.

The U-Peeler and its components may only be used when the following preconditions are met:

- The use may only be carried out within the scope of the intended use.
- The U-Peeler and its components must be generally and mechanically in perfect condition.



## 6.1. General safety guidelines

The basic condition for safely handling and a hassle-free operation of the product is the knowledge about the fundamental safety guidelines and safety regulations. This instruction manual contains essential information on how to handle the product, including its components and accessories, safely. The safety guidelines have to be acknowledged and observed by everyone working with the product. These instructions shall be read and implemented in accordance with the relevant standards, workplace health and safety legislation, installation instructions, Codes of Practice and technical connection guideline in force in your country.

- Keep and store tools that are not in use away from children. Do not let people, who are not familiar with the product or have not read and understood the instruction manuals, use the device. Tools are dangerous if being used by inexperienced users.
- Maintain the tool with care. Check for misalignment or binding of moving parts, breakage of parts and any other condition that may affect the operation of the tools. If damaged, have the tool repaired before use. Many accidents are caused by poorly maintained tools.
- Keep your products clean. Follow the servicing instructions and the instructions for changing the tools. Keep oil and grease away from the handles.
- Use the product, accessories etc. in accordance with these instructions. Take the working conditions and the work to be performed into account. The use of the product for applications differing from the application scope could result in a hazardous situation.
- Pipes and other workpieces must be firmly clamped or fixed. Poorly clamped or fixed workpieces may hurt you or affect your safe foothold.

### **NOTE**



#### **Read the provided documentation!**

Read the provided documentation thoroughly to prevent applications errors and to work safer and according to the scope of application with the respective product. Reading the documentation thoroughly and completely helps preventing accidents due to improper use and eases the work with the product.



- All users of the product must thoroughly read and understand the provided documentation prior to use.

### **DANGER**



#### **Danger due to non-compliance with accident prevention regulations!**

In order to be able to use the product safely, the knowledge of the applicable accident prevention regulations in your country is absolutely necessary. Working with the product without the knowledge of the valid accident prevention regulations carries a great risk for irreversible injuries and property damage.

- Germany: Familiarize yourself with the general accident prevention regulations (UVV).
- International: International: Familiarize yourself with the standards and regulations for accident prevention in your country. Take note of these and act accordingly.

## 6.2. Duty of care of the operator

### NOTE



#### Minimizing risks

Above all, the safety at the place of installation of the product can only be achieved if all necessary risk-minimizing measures are taken and avoidable risks are ruled out from the outset. This is the duty of care of the operator. All users of the product must thoroughly read and understand the provided documentation prior to use.

#### The operator is obliged to allow the usage of the product only to people that:

- are familiar with the basic regulations on work safety and accident prevention and are thoroughly instructed in the proper handling of the product, its components and accessories.
- have read and understood the complete documentation of the product, its components and accessories.
- are sufficiently qualified and authorized to use the product as intended.
- are fully trained and familiarized with the process of scraping of PE pipes.

#### Furthermore, the operator must ensure that:

- responsibilities of the staff / user shall be clearly defined with regard to transport, installation, dismantling, commissioning, setting up and adjustment, operation, maintenance and inspection, repair and disassembly.
- the product and its components are used only in accordance with the intended use.
- the product, its components and accessories is used only together with accessories and retrofit parts provided by the manufacturer.
- the product and its components must be in perfect and functional condition.
- the parts of the personal protective equipment necessary for carrying out the work are available and used for the personnel employed.
- the documentation associated with the product and its components is always fully and legibly available on the job site.
- at each change of ownership, or when loaned to other persons, all documentation must be included and its importance pointed out.
- the general and local regulations for accident prevention and environmental protection are provided.
- all safety and danger warnings on the product, its components and accessories are kept in readable condition and renewed if damaged.

**Technical condition of the product:**

Subsequent requirements are based on the technical condition of the product. Compliance with these requirements must be ensured by the operator.

- The product may only be used as intended.
- The product must be checked for perfect technical condition before each use.
- No unauthorized or arbitrary modifications or manipulations of the product, its components or accessories may be made.
- The full technical documentation must always be kept completely and legibly at the place of use of the product for inspection.

**6.3. Duty of care of the user****All persons entrusted with work on the tool have the obligation to:**

- familiarize themselves with the basic regulations on work safety and accident prevention before starting to work.
- thoroughly read the entire documentation.
- inform oneself about the functioning of the product, its components and accessories.

**6.4. Safety in the work area**

- Keep your work area clean and well lit. Working in cluttered or dark areas can easily lead to accidents.
- Prevent the product from unintentional movement or dropping and assume a secure foothold.
- Keep children and bystanders at distance while operating the product. Distractions can cause you to lose control over the tool.
- Avoid an unnatural posture. Always make sure that you have a safe foothold and stay in balance. This ensures optimum control of the product in unexpected situations.
- Working overhead in areas not completely visible (e.g. under a pipe) is prohibited.

## 6.5. Personal protective equipment

### NOTE



#### Obligation to use the personal protective equipment!

During transport, assembly, assembly and disassembly of the product, the respective personnel must wear and use the appropriate PPE.

Which parts of the PPE must be used must be evaluated on an individual basis, determined by the operator and announced to the personnel.



The nature and extent of the PPE to be worn must be assessed and determined for the individual case.

The following PPE is recommended when working with this product:



#### Wear eye protection!

When working with the product, eye protection should always be worn. Flying chips or foreign objects can damage your eyesight.



#### Wear safety shoes!

Wearing safety shoes protects the feet from falling objects and reduces the risk of slipping.

## 6.6. Qualification of personnel

Only persons with sufficient knowledge in the field of peeling PE pipes may work with this product. This knowledge may have been gained through several years of professional experience, training, instruction or other training. Persons who do not have sufficient knowledge in this area must be supervised and instructed by a person with appropriate knowledge.

### WARNING



#### Danger due to insufficient personnel qualification

If insufficiently skilled operators work with the product or are in the work area, there is a risk of serious injury or property damage.

- Allow only qualified personnel to work with the product.
- Personnel in training may only work with the product under the supervision of an experienced person.

## 6.7. Deadlines for recurring checks

Action	Interval
Cleaning the product after completion of the work.	Each working day
Checking the handles for damage.	Each working day
Check the rollers for perfect function.	Each working day
Visual inspection of the peeling blade for damage.	Each working day
Maintenance by the manufacturer or an authorized service station	Annual

## 6.8. Dangers during individual work phases

### 6.8.1. Dangers during transport and assembly

#### Transport

No special dangers.

#### Installation

No special dangers.

#### **CAUTION**



##### **Risk of cutting injuries on sharp edges**

In the event of carelessness or improper use, the sharp edges and cutting edges of the peeling blade may result in cutting injuries to the user.



- Avoid touching the peeling blade with your bare hands.
- Wear suitable protective gloves when handling.



##### **Wear suitable protective gloves!**

Wear suitable protective gloves during transport and assembly.

### 6.8.2. Dangers during operation

The operator must have been instructed by the operator in the handling of the product. Working with the product without instruction is prohibited. The proof obligation lies with the operator.

Use the product only in accordance with its intended use. Activities that impair safety are to be avoided.

#### **WARNING**



##### **Injury due to improper / unintended operation**

Incorrect or unintentional operation of the tool can lead to injury and / or property damage.

- Before using the tool, check that all components are free from damage.
- Never operate the tool if it has any damage.

### 6.8.3. Dangers during removal

The disassembly of the components may only be carried out by trained personnel who have read and understood all parts of the documentation.

#### **CAUTION**



##### **Risk of cutting injuries on sharp edges**

In the event of carelessness or improper use, the sharp edges and cutting edges of the peeling blade may result in cutting injuries to the user.



- Avoid touching the peeling blade with your bare hands.
- Wear suitable protective gloves when handling.



##### **Wear suitable protective gloves!**

Wear suitable protective gloves during transport and assembly.

## **6.9. Device specific dangers**

The product has no device-specific hazards.

## **6.10. Residual risk**

Despite all security measures a residual risk remains. Technically non-excludable risks are:

- If the handles are damaged, they may become detached or torn off.

## 7. Scope of delivery

### 7.1. Metric sizes



**Note**

The U-Peeler is available in different versions. The scope of delivery differs, depending on the ordered variant.

**The given technical information is valid for the standard setup of the tool. Depending on the ordered setup there may be variations. Errata and technical modifications reserved!**

		U-Peeler									
		63 mm	75 mm	90 mm	110 mm	125 mm	140 mm	160 mm	180 mm	200 mm	225 mm
Code		4_4800_063	4_4800_075	4_4800_090	4_4800_110	4_4800_125	4_4800_140	4_4800_160	4_4800_180	4_4800_200	4_4800_225
Instruction manual	1 x	EN280									
Auxiliary handle	1 x	-									
Plastic suitcase	1 x	1_2800_065									

		U-Peeler		
		250 mm	280 mm	315 mm
Code		4_4800_250	4_4800_280	4_4800_315
Instruction manual	1 x	EN280		
Auxiliary handle	1 x	2_4800_003		
Plastic suitcase	1 x	1_2800_022		

## 7.2. Inch IPS

U-Peeler							
	2" IPS	3" IPS	4" IPS	6" IPS	8" IPS	10" IPS	12" IPS
<b>Code</b>	4_4800_060	4_4800_088	4_4800_114	4_4800_168	4_4800_219	4_4800_273	4_4800_323
<b>Instruction manual</b>	1 x	EN280					
<b>Auxiliary handle</b>	1 x	-				2_4800_003	
<b>Plastic suitcase</b>	1 x	1_2800_065				1_2800_022	

## 7.3. Inch DIPS

U-Peeler						
	3" DIPS	4" DIPS	6" DIPS	8" DIPS	10" DIPS	12" DIPS
<b>Code</b>	4_4800_100	4_4800_121	4_4800_175	4_4800_229	4_4800_281	4_4800_335
<b>Instruction manual</b>	1 x	EN280				
<b>Auxiliary handle</b>	1 x	-			2_4800_003	
<b>Plastic suitcase</b>	1 x	1_2800_065		1_2800_022		



## 8. Technical data

### 8.1. Metric sizes

		U-Peeler										
		63 mm	75 mm	90 mm	110 mm	125 mm	140 mm	160 mm	180 mm	200 mm	225 mm	
Code		4_4800_063	4_4800_075	4_4800_090	4_4800_110	4_4800_125	4_4800_140	4_4800_160	4_4800_180	4_4800_200	4_4800_225	
Suitable for pipes made of		PE, PE-HD, PE-X										
Peeling blade		RST2							CPT3			
Peeling depth	[mm]	0.2 (0.15 to 0.25)							0.3 (0.25 to 0.35)			
Product dimensions L×W×H	[mm]	210×100×90	230×100×100	240×100×105	260×100×115	280×100×125	250×100×135	310×100×150	330×100×160	350×100×170	370×100×180	
Product weight	[kg]	0.7	0.8	0.8	0.9	0.9	0.9	1	1	1	1.4	
Packaging dimensions L×W×H	[mm]	340×300×130										
Packaging material		Plastic										
Packaging type		Suitcase										
Packaging weight	[kg]	1										
Transport weight	[kg]	1.7	1.8	1.8	1.9	1.9	1.9	2	2	2	2.4	

The given technical information is valid for the standard setup of the tool. Depending on the ordered setup there may be variations.

Errata and technical modifications reserved!

		U-Peeler		
		250 mm	280 mm	315 mm
Code		4_4800_250	4_4800_280	4_4800_315
Suitable for pipes made of		PE, PE-HD, PE-X		
Peeling blade		CPT3		
Peeling depth	[mm]	0.3 (0.25 to 0.35)		
Product dimensions L×W×H	[mm]	420×100×200	45×100×280	490×100×300
Product weight	[kg]	1.2	1.5	1.5
Packaging dimensions L×W×H	[mm]	450×360×150		
Packaging material		Plastic		
Packaging type		Suitcase		
Packaging weight	[kg]	1.5		
Transport weight	[kg]	2.7	3	3

The given technical information is valid for the standard setup of the tool. Depending on the ordered setup there may be variations.

Errata and technical modifications reserved!

## 8.2. Inch IPS

		U-Peeler						
		2" IPS	3" IPS	4" IPS	6" IPS	8" IPS	10" IPS	12" IPS
Code		4_4800_060	4_4800_088	4_4800_114	4_4800_168	4_4800_219	4_4800_273	4_4800_323
Suitable for pipes made of		PE, PE-HD, PE-X						
Peeling blade		RST2				CPT3		
Peeling depth	[mm]	0.2 (0.15 to 0.25)				0.3 (0.25 to 0.35)		
Product dimensions L×W×H	[mm]	230×100×90	260×100×105	280×100×120	340×100×150	390×100×180	450×100×280	500×100×300
Product weight	[kg]	0.7	0.8	0.8	1	1.1	1.5	1.6
Packaging dimensions L×W×H	[mm]	340×300×130					450×360×150	
Packaging material		Plastic					Plastic	
Packaging type		Suitcase					Suitcase	
Packaging weight	[kg]	1					1.5	
Transport weight	[kg]	1.7	1.8	1.8	2	2.1	3	3.1

The given technical information is valid for the standard setup of the tool. Depending on the ordered setup there may be variations.

Errata and technical modifications reserved!

### 8.3. Inch DIPS

		U-Peeler					
		3" DIPS	4" DIPS	6" DIPS	8" DIPS	10" DIPS	12" DIPS
Code		4_4800_100	4_4800_121	4_4800_175	4_4800_229	4_4800_281	4_4800_335
Suitable for pipes made of		PE, PE-HD, PE-X					
Peeling blade		RST2			CPT3		
Peeling depth	[mm]	0.2 (0.15 to 0.25)			0.3 (0.25 to 0.35)		
Product dimensions L×W×H	[mm]	270×100×115	290×100×125	340×100×160	400×100×190	450×100×280	510×100×310
Product weight	[kg]	0.8	0.9	1	1.1	1.5	1.6
Packaging dimensions L×W×H	[mm]	340×300×130			450×360×150		
Packaging material		Plastic			Plastic		
Packaging type		Suitcase			Suitcase		
Packaging weight	[kg]	1			1.5		
Transport weight	[kg]	1.8	1.9	2	2.6	3	3.1

The given technical information is valid for the standard setup of the tool. Depending on the ordered setup there may be variations.

Errata and technical modifications reserved!

## 9. Transport, Installation and removal, storing



### Qualification of personnel

The tool may only be transported, installed, removed and stored by persons with relevant professional experience and expertise in using the tool.



### Safety

User and operator are responsible. Observe all safety instructions in this instruction manual as well as all valid safety regulations.

### 9.1. Transport damage

### 9.2. Packaging

The tool is delivered in a plastic suitcase. Keep it for transport and storage



### Damage to the packaging

Damage to the packaging may indicate damage to the tool. If in doubt about the condition of the tool, contact the manufacturer or your dealer.

### 9.3. Assembly and installation

Hold the U-Peeler by both handles and position it on the pipe. The peeling blade should be max. halfway in the marked area of the pipe. By firmly pressing the two handles down, the U-Peeler is snapped onto the pipe.

#### Conditions for the installation site

- ❖ Make sure you have enough space and good lighting.  
The pipe must be free of dirt and foreign objects.
- ❖ Provide a free escape route in case you lose control of the tool during assembly.
- ❖ If necessary, set up a tent to protect the work area and the tool from the effects of the weather, such as strong sunlight, rain or moisture.

#### Space requirements

- ❖ Make sure there is at least approx. 10 cm of space around the pipe section to be peeled.

### 9.4. Storage

Store the product in its transport suitcase, protected from the weather. The temperature should be between 5 and 25 ° C with a humidity of not more than 60%.

## 10. Installation



### Qualification of personnel

- All persons involved in the assembly and installation must have read and understood this instruction manual and in particular all safety instructions.



### Important information about your safety

You are responsible!

All safety instructions in this instruction manual and the generally applicable measures for accident prevention must be adhered to.

#### Requirement:

- ! The safety instructions are observed.



### Installation example

The following installation instructions is based on a general description. It is identical for all sizes of the tool.

### 10.1. General checks and measures before usage

- ! Check the peeling blade for damages. A dull or damaged peeling blade must be replaced.
- ! Check the rollers. If the rollers are worn, difficult to turn or blocked, they must be replaced.
- ! Check that the handles are not loose.
- ! Clean the pipe. Use a clean cloth free of dirt and grease to remove mud, sand and dirt from the surface you want to peel. If necessary additionally use certified pipe cleaner.
- ! Mark the insertion depth of the fitting resp. the area of contact of the saddle according to the processing guidelines of the fitting manufacturer with a certified marker. The area to be scraped should be marked with wave-like markings 90 degrees to the direction of the peeling.

## 10.2. Using the U-Peeler

### Requirement:

! All preparatory measures have been taken.

### 10.2.1. Course of action for the peeling of pipe ends

#### Installation for the peeling of pipe ends

1. Install the U-Peeler so that approximately between 1/2 and 2/3 of the peeling blade make contact with the pipe. That ensures that during the first revolution no area of the pipe remains unpeeled.

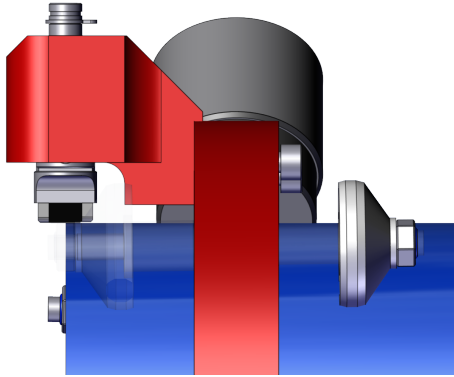

### 10.2.2. Course of action for the peeling of saddle areas

#### Installation for the peeling of saddle areas

1. Position the U-Peeler on the desired location on the pipe. The blade should be set on the middle of the outer limit of the marking on the area of contact.

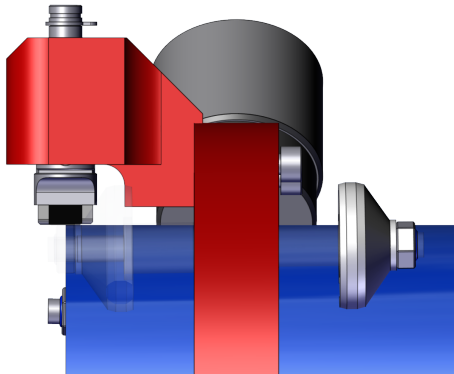

### 10.3. Pressing the U-Peeler onto the pipe

#### CAUTION



#### Risk of cutting injuries on sharp edges

In the event of carelessness or improper use, the sharp edges and cutting edges of the peeling blade may result in cutting injuries to the user.



- Avoid touching the peeling blade with your bare hands.
- Pay attention to the sharp edge of the peeling blade when handling.
- Wear suitable protective gloves when handling.

#### Requirement:

- ! The safety instructions are observed.
- ! Tools are ready.

#### Pressing the U-Peeler onto the pipe:

1. Put the U-Peeler with its blue Rollers onto the pipe surface at the location where you want to start peeling. Then press down on both adjustment knobs simultaneously. The U-Peeler snaps onto the pipe and is ready for peeling. Note that the indicator on the blade holder is now pushed out.

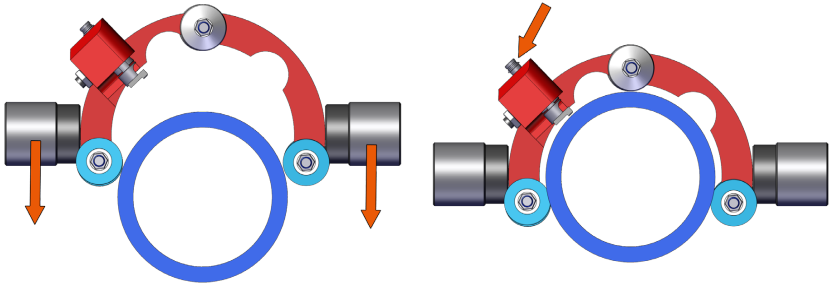



## 11. Peeling



### Note

Due to the features of the tool, like the ovality compensation and the tiltable blade, an even chip removal on pipes with ovalities or slightly collapsed ends can be performed.

### Requirement:

- ! The peeling area was cleaned and freed from foreign objects.
- ! All safety guidelines have been read and understood.
- ! The chapter "Installation" has been read completely.
- ! Fix or clamp the pipe before you begin peeling it to improve the peeling result and prevent accidents.
- ! Position yourself so that the cutting edge of the peeler blade of the installed tool faces towards you.
- ! Your position should ideally be 90° to the pipe so that no axial forces influence the set feed of the tool.

### Peeling the pipe:

1. Grip the peeling tool by the adjustment knob and pull it straight towards you.

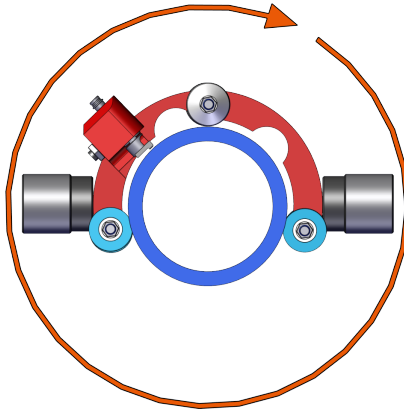

2. Watch how the chip is removed. If the peel width is maximum 2/3 of the blade width continue moving the U-Peeler around the pipe until you have scraped the desired area of the pipe surface.

### NOTE



### Evaluating the peeling result

The thickness of the peel is not a good criterion for the quality of the peel.

To evaluate the peeling result you should not use the peel thickness as a criterion. The chip may have been compressed by the peeling and thus falsely indicate that too much material was peeled off. Measure the outside diameter of the unpeeled pipe and then measure the outside diameter of the peeled pipe. This will tell you how much material has been peeled off.

If you measure the peeled area of the pipe, you must then clean it again with an approved pipe cleaner!

## 12. Removal of the U-Peeler

### Requirement:

! The peeling process is finished.

### Pulling the U-Peeler off:

1. To remove the U-Peeler from the pipe take hold of both adjustment knobs and pull the tool upwards, like shown in the picture.

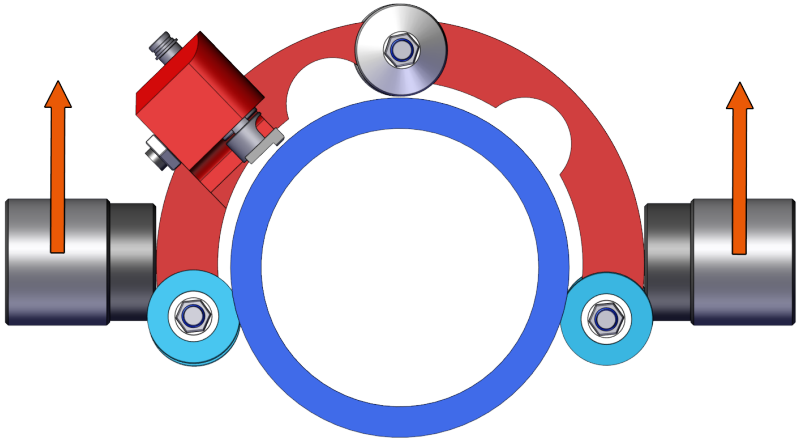

### Note

After removing the tool from the pipe always make sure that you have completely peeled the desired area.

## 13. Maintenance, repair and cleaning



### Important information about your safety

You are responsible!

All safety instructions in this instruction manual and the generally applicable measures for accident prevention must be adhered to.

The product, its components and accessories must be handled with care and maintained regularly in order to achieve the best possible work result.

### NOTE



#### Maintenance work

All maintenance beyond the removal of simple mechanical disturbances, such as for example disassembling the product into its components, may only be performed by the manufacturer or an authorized service center within the first 24 months of purchase. If you are unsure whether you are allowed to perform a particular activity, please contact your dealer or the manufacturer.

For safety reasons, even after the expiry of the 24 months, we strongly advise that repairs and maintenance be carried out only by the manufacturer or an authorized service station.

**Tampering with components of the product without prior consultation of your dealer or the manufacturer may compromise safety and is therefore considered improper use.**

**In all correspondence, please provide the serial number (S/N) as shown on the type plate of the tool.**

### 13.1. Qualification of personnel



#### Maintenance and repair

- Only personnel with user and specialist knowledge in handling the product may service this according to the specifications.



#### Cleaning

- The personnel responsible for the cleaning must at least have read and understood the safety instructions. Furthermore, it is only necessary that the generally valid procedures and safety regulations are observed when handling power tools.

### 13.2. Maintenance by laymen

Laymen should not perform any work on the product without the supervision of experienced people or professionals. Under supervision, laymen may carry out the following maintenance work on the product:

- Remove dirt and grime with a soft cloth or cotton bud.
- General cleaning work

### 13.3. Maintenance by specialists

The manufacturer and service stations approved by the manufacturer are able to carry out all necessary maintenance and repair work that will bring your product to a technically sound and safe condition. The following activities may only be carried out by the manufacturer or an authorized service station:

- Replacement of components that require disassembly of the product.

### 13.4. Maintenance cycles for safe operation

Please note that the product is a technically demanding machine for field application. In accordance with the product-specific applicable standards and regulations in your country (eg DGUV V3), this must be regularly checked and maintained. The maintenance interval is 12 months, with heavy use shorter intervals are recommended.

#### NOTE



#### Damage due to poor maintenance

If maintenance and service is omitted and maintenance intervals are exceeded, damage to the product or other property damage may result from product use.

**Regular cleaning, checks and maintenance of the maintenance cycle can avoid this.**

#### 13.4.1. Cyclical maintenance activities



#### Important information about your safety

You are responsible!

All safety instructions in this instruction manual and the generally applicable measures for accident prevention must be adhered to.



#### Instructions for components of the product or external suppliers

Read the entire documentation. That's the only way you can reliably carry out your maintenance work.

The following activities are intended to maintain the proper and safe condition of the product. The stated intervals must be observed.

If defects in the product or parts of the product are detected during the execution of the activities, they must be rectified before reuse. Until the defects have been eliminated, the product must be taken out of service.

The staff responsible for carrying out the activities ensures that all activities have been completed successfully.

Action	Interval
Cleaning the product after completion of the work.	Each working day
Checking the handles for damage.	Each working day
Check the rollers for perfect function.	Each working day
Visual inspection of the peeling blade for damage.	Each working day
Maintenance by the manufacturer or an authorized service station	Annual

### 13.5. Measures after maintenance or servicing

After maintenance or servicing, be sure to inspect all safety features of the product and to ensure that the product functions properly and safely. Do not work with the product without prior checking.

### 13.6. Cleaning

To achieve an optimum work results the tool has to be handled with care and maintained frequently. Pollution by sand and dirt has to be avoided or, if necessary, removed with a soft cloth or a Q-tip.

#### NOTE



#### Damage due to incorrect cleaning

Use a damp cloth for cleaning. Do not use aggressive cleaners.

### 13.7. Changing the peeling blade

#### CAUTION



#### Risk of cutting injuries on sharp edges

In the event of carelessness or improper use, the sharp edges and cutting edges of the peeling blade may result in cutting injuries to the user.



- Avoid touching the peeling blade with your bare hands.
- Wear suitable protective gloves when handling.

#### Requirement:

! The tool is not yet pressed onto the pipe.

#### Changing the peeling blade:

1. Loosen the hexagon socket head screw (2.5 mm) that secures the scraper blade on the blade holder with a hex key and remove the old scraper blade.

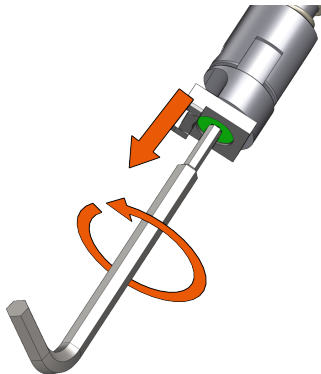

2. Make sure that the peeler blade lies flat on the blade holder and that it touches the stop with its backside.

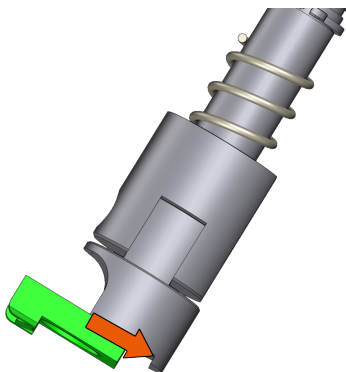

3. Hold the scraper blade in this position and screw the hexagon socket head screw (2.5 mm) in again with a hex key.

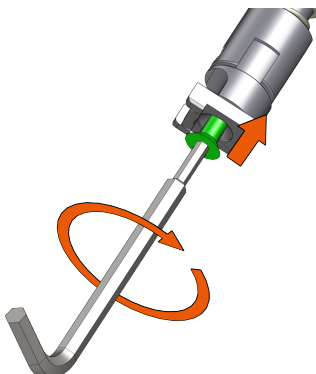

#### **NOTE**



**Make sure that a suitable spare blade is used**

The spare blades are incompatible with the pipe end peelers of PF-Schweisstechnologie GmbH, because these have a different edge.

**Pay attention to the laser marking of the spare blade. The marking must start with "RST". Only such a replacement blade is suitable.**

## **14. Maintenance and service by the customer service**

The maintenance and the related checks are important for your safety and the continuous working reliability and safety of the product.

Should the product, its components or accessories fail despite the great care taken in manufacturing and testing it, the necessary repairs should only be carried out by an after-sales service centre authorised by the manufacturer.

Have this product serviced only by a qualified person authorized by the manufacturer and only with original spare parts. This ensures that the safety of the product is maintained.

During maintenance, the product will be upgraded to the current technical standard of our devices and you get a 3-month guarantee on function for the maintained tool, excluding wearing parts.

### **14.1. Wearing parts**

The following components of the product are wearing parts. These components may wear out through use. These parts are not covered by the 24-month warranty or the 3-month functional warranty after maintenance by the manufacturer or a service station authorized by the manufacturer.

- Peeler blade
- Running wheel (incl. securing ring)

### **14.2. Addresses of service stations**

Always contact your dealer or the manufacturer of the product.

### **14.3. Repackaging before transport**

If the product is to be transported after use, it must be packed again in the packaging (boxes, suitcases) provided. This ensures that the product is best protected against transport damage.









## **15. Decommissioning, Disassemble, Disposal**

The products, its components and accessories must be disposed of in an environment-friendly way sorted by materials. For products with hydraulic drive: Make sure that hydraulic oil and other lubricants are disposed of properly.

### **15.1. Environment-friendly disposal**

The U-Peeler must be disposed of in an environment-friendly way sorted by materials.

## 16. Troubleshooting

	<b>The peel is too thick.</b>
	<ul style="list-style-type: none"><li>○ The peel was compressed.</li><li>○ A peeling blade with too large peeling depth was used.</li></ul>
	<ul style="list-style-type: none"><li>➤ The thickness of the peel is not a good criterion for the quality of the peel. The chip may have been compressed by the peeling and thus falsely indicate that too much material was peeled off. Measure the outside diameter of the unpeeled pipe and then measure the outside diameter of the peeled pipe. This will tell you how much material has been peeled off.</li><li>➤ Check and exchange the peeling blade.</li></ul>
	<b>The peel is too thin, uneven or tears off.</b>
	<ul style="list-style-type: none"><li>○ The peeling blade is worn.</li><li>○ The contact pressure of the peeling blade is too low.</li><li>○ The tool is moved too fast or jerkily around the pipe.</li><li>○ The pipe has scratches or flat / compressed spots.</li></ul>
	<ul style="list-style-type: none"><li>➤ Check and replace the peeling blade, if necessary.</li><li>➤ Check the blade holder for dirt that blocks it and remove it. If necessary, use spray grease to release the blockage. Apply PTFE paste to the sides of the blade holder. ATTENTION: The pipe must not come into contact with these lubricants!</li><li>➤ Work continuously at the same speed.</li><li>➤ Carefully check the part of the pipe to be peeled to ensure that it complies with the processing guidelines. If in doubt, ask the pipe manufacturer.</li></ul>
	<b>The peeled surface has grooves or scratches.</b>
	<ul style="list-style-type: none"><li>○ The peeling blade is worn.</li><li>○ A peeling blade of a pipe end peeler was used.</li><li>○ There are resp. were foreign bodies in the pipe surface when it was peeled.</li></ul>
	<ul style="list-style-type: none"><li>➤ Check and exchange the peeling blade.</li><li>➤ Check the pipe surface for pushed-in dirt and debris before peeling.</li><li>➤ If in doubt, cut out the peeled piece of pipe.</li></ul>